

to those of an R3 General Residence District and a corresponding use district is hereby established in the area above described.

SECTION 2. This ordinance shall be in force and effect from and after its passage and due publication.

*Reclassification Of Area Shown On Map Number 16-G.*

(As Amended)

(Application Number 13238)

**RPD 740 AA**

*Be It Ordained by the City Council of the City of Chicago:*

SECTION 1. That the Chicago Zoning Ordinance be amended by changing the Residential Planned Development Number 740 as shown on Map Number 16-G in the area bounded by:

West 69<sup>th</sup> Street; South Laflin Street; the public alley next north of and parallel to West 69<sup>th</sup> Street; and a line 75 feet east of and parallel to South Bishop Street,

to Residential Planned Development Number 740, as amended, and a corresponding use district is hereby established in the area above described.

SECTION 2. This ordinance shall be in force and effect from and after its passage and due publication.

Plan of Development Statements referred to in this ordinance read as follows:

*Residential Planned Development Number 740, As Amended.*

*Plan Of Development Statements.*

1. The area delineated herein as a Residential Planned Development consists of a net site area of approximately ninety-eight hundredths (.98) of an acre (forty-two thousand five hundred seventeen (42,517) square feet) which is controlled by the City of Chicago for purposes of this Residential Planned



Development. The City of Chicago has authorized Wheeler House, L.P., an Illinois limited partnership, to proceed as applicant ("Applicant") for purposes of this Residential Planned Development. The developer is SW Development, 7434 North Skokie Boulevard, Skokie, Illinois 60077.

2. The Applicant shall obtain all applicable official reviews, approvals or permits which are necessary to implement this Plan of Development. Any dedication or vacation of streets or alleys or easements or adjustments of rights-of-way or consolidation or resubdivision of parcels shall require separate submittal on behalf for the Applicant or its successors, assignees or grantees and approval by the City Council.
3. The requirements, obligations and conditions applicable within the Planned Development shall be binding upon the Applicant, its successors and assigns and if different than the Applicant, the owners of all the property within the Planned Development or any homeowners association(s) formed to succeed the Applicant for purposes of control and management of any portion of the Planned Development, the legal title holder or any ground lessors. Furthermore, pursuant to the requirements of Section 11.11-1 of the Chicago Zoning Ordinance, the property, at the time applications for amendments, modifications or changes (administrative, legislative or otherwise) to this Planned Development are made, shall be under single ownership or under single designated control. Single designated control for purposes of this paragraph shall mean that any application to the City for any amendment to this Planned Development or any modification or change thereto (administrative, legislative or otherwise) shall be made by the Applicant, or the owners of all the property within the Planned Development. No amendment may be sought without written approval by the owners of the property.
4. This Plan of Development consists of these thirteen (13) statements, a Bulk Regulations and Data Table; a Planned Development Boundary and Property Line Map; an Existing Zoning Map; a Site Landscape Plan; an Ornamental Metal Fence and Gate Detail; and Building Elevations revised on February 22, 2001, prepared by Schipporeit, Inc. and Cox Limited, which are all incorporated herein. Full size sets of the Site Landscape Plan and Building Elevations are on file with the Department of Planning and Development. This Plan of Development is in conformity with the intent and purposes of the Chicago Zoning Ordinance (Title 17 of the Municipal Code of Chicago) and all requirements thereof and satisfies the established criteria for approval of a Planned Development. These and no other controls shall apply to the area delineated herein.
5. The following uses shall be permitted within the areas delineated herein:



- multi-family dwelling units for the elderly; accessory parking; and related accessory uses.
6. Identification signs shall be permitted within the Planned Development subject to the review and approval of the Department of Planning and Development. Temporary signs, such as construction and marketing signs shall be permitted within the Planned Development subject to review and approval of the Department of Planning and Development.
  7. Any service drives or other ingress or egress including emergency vehicle access shall be adequately designed, constructed and paved in accordance with the Municipal Code of Chicago and the regulations of the Department of Transportation in effect at the time of construction. There shall be no parking or storage of garbage receptacles within such paved areas. Ingress and egress shall be subject to the review and approval of the Department of Transportation and the Department of Planning and Development. Off-street parking and off-street loading facilities shall be provided in compliance with this Plan of Development subject to review of the Departments of Transportation and Planning and Development.
  8. In addition to the maximum height of any building or any appurtenance attached thereto, the height of any improvement shall also be subject to the height limitations approved by the Federal Aviation Administration.
  9. The maximum permitted floor area ratio shall be in accordance with the attached Bulk Regulations and Data Table. For purposes of F.A.R. calculations and floor area measurements, the definition in the City of Chicago Zoning Ordinances shall apply.
  10. Improvements of the property, including landscaping and all entrances and exits shall be designed and installed in substantial conformance with the Bulk Regulations and Data Table and the Site Landscape Plan attached hereto and made a part hereof. Landscaping shall be installed and maintained at all times in accordance with the Site Landscape Plan and the Parkway Tree Provisions of the Chicago Zoning Ordinance and corresponding regulations and guidelines. Installation of parkway landscaping is subject to review and permit by any departments or agencies required to approved.
  11. The terms, conditions and exhibits of this Planned Development Ordinance may be modified, administratively, by the Commissioner of the Department



of Planning and Development upon the written request for such modification by the Applicant and after a determination by the Commissioner of the Department of Planning and Development, that such a modification is minor, appropriate and is consistent with the nature of the improvements contemplated in this Planned Development. Any such modification of the requirements of this statement by the Commissioner of the Department of Planning and Development shall be deemed to be a minor change in the Planned Development as contemplated by Section 11.11-3(c) of the Chicago Zoning Ordinance.

12. The Applicant acknowledges that it is in the public interest to design, construct and maintain all buildings in a manner which promotes, enables and maximizes universal access throughout the property. Plans for all buildings and improvements on the property shall be reviewed and approved by the Mayor's Office for People with Disabilities (M.O.P.D.). To ensure compliance with all applicable laws and regulations related to access for persons with disabilities and to promote the highest standard of accessibility. No approvals shall be granted pursuant to Section 11.11-3(b) of the Chicago Zoning Ordinance until the Director of M.O.P.D. has approved detailed construction drawings for each building or improvement.
13. If substantial construction has not yet begun within the Planned Development within six (6) years of the date of passage of the Planned Development, the zoning of that property shall revert to the underlying R3 General Residence District and B4-1 Restricted Service District. The six (6) year period may be extended for one (1) additional year if, before expiration, the Commissioner of the Department of Planning and Development determines that there is good cause for such an extension.

[Existing Zoning Map; Planned Development Boundary and Property Line Map; Site Landscape Plan; Ornamental Metal Fence and Gate Detail; and Building Elevation Drawings referred to in these Plan of Development Statements printed on pages 53981 through 53985 of this Journal.]

Bulk Regulations and Data Table referred to in these Plan of Development Statements reads as follows:



*Residential Planned Development Number 740, As Amended.*

*Bulk Regulations And Data Table.*

Gross Site Area:	72,896 square feet (1.68 acres).
Net Site Area (Total):	Gross Site Area (72,896 square feet) - Area in Public Street and Alleys = Net Site Area of 42,517 square feet (.98 acres).
Maximum Floor Area Ratio:	1.71.
Maximum Number of Residential Units:	89 units.
Maximum Site Coverage:	In accordance with Site Landscape Plan.
Minimum Number of Off-Street Parking Spaces:	23.
Minimum Number of Off-Street Loading Docks:	1.
Minimum Building Setbacks:	In accordance with Site Landscape Plan.
Maximum Building Height:	In accordance with Building Elevations.







### Planned Development Boundary And Property Line Map.

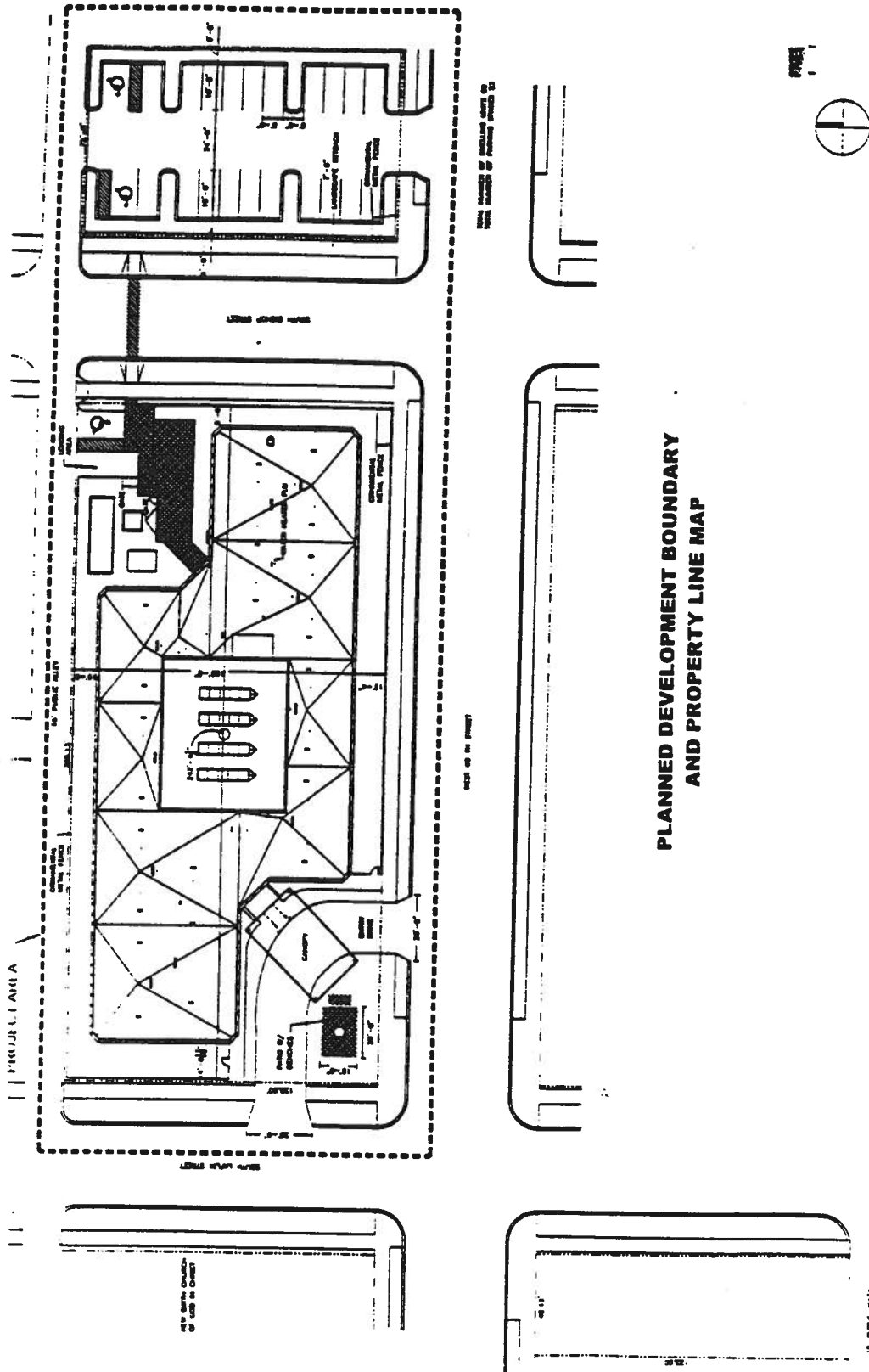

**PLANNED DEVELOPMENT BOUNDARY  
AND PROPERTY LINE MAP**

**WHEELER HOUSE SENIOR RESIDENCES**  
 1450 WEST 69TH STREET  
 CHICAGO, ILLINOIS  
 Submission Date: January 10, 2001

**SCHIPPORRETT INC. G-170**  
 ASSOCIATED ARCHITECTS







Ornamental Metal Fence And Gate Detail.

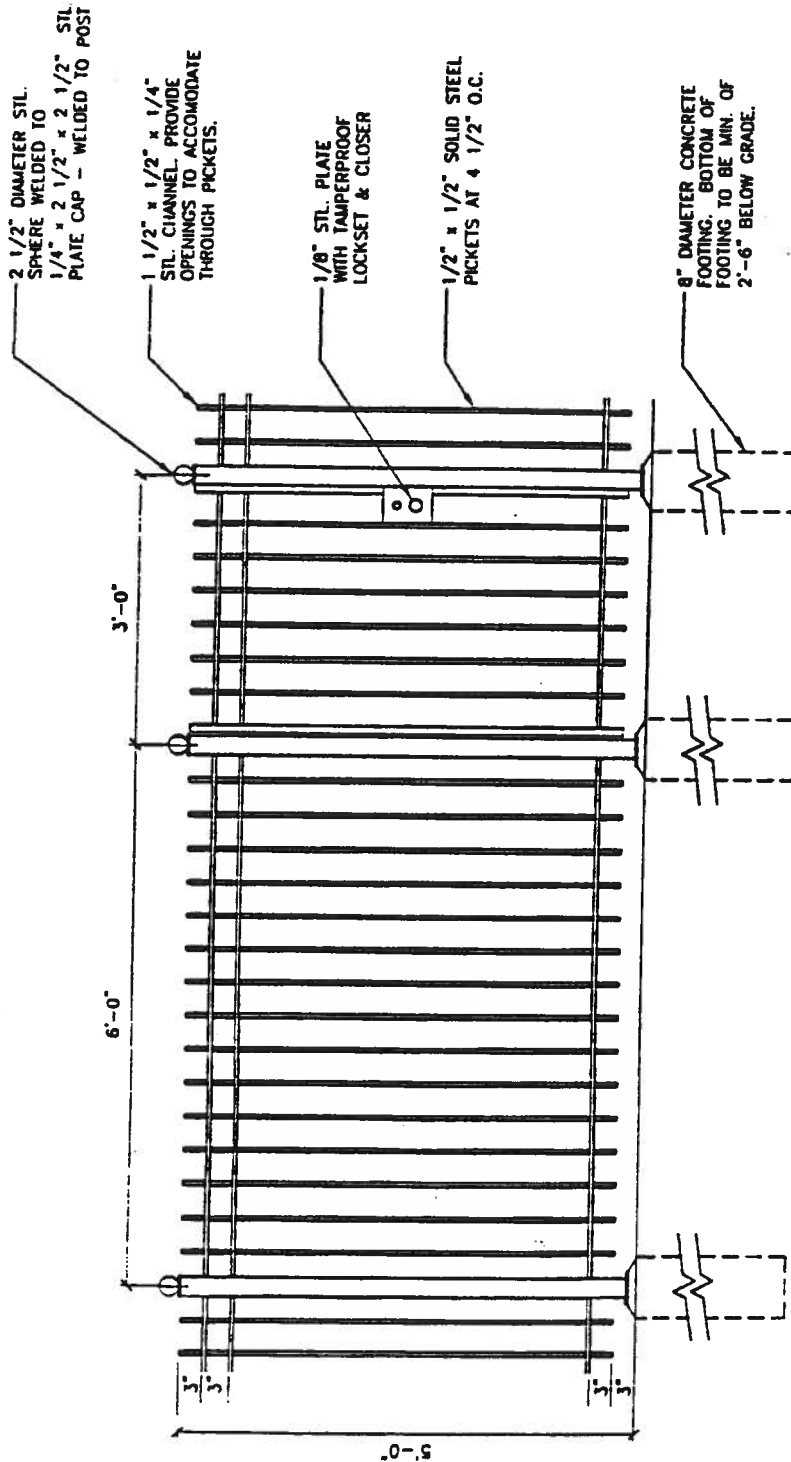

ORNAMENTAL METAL FENCE AND GATE DETAIL



Building Elevations.

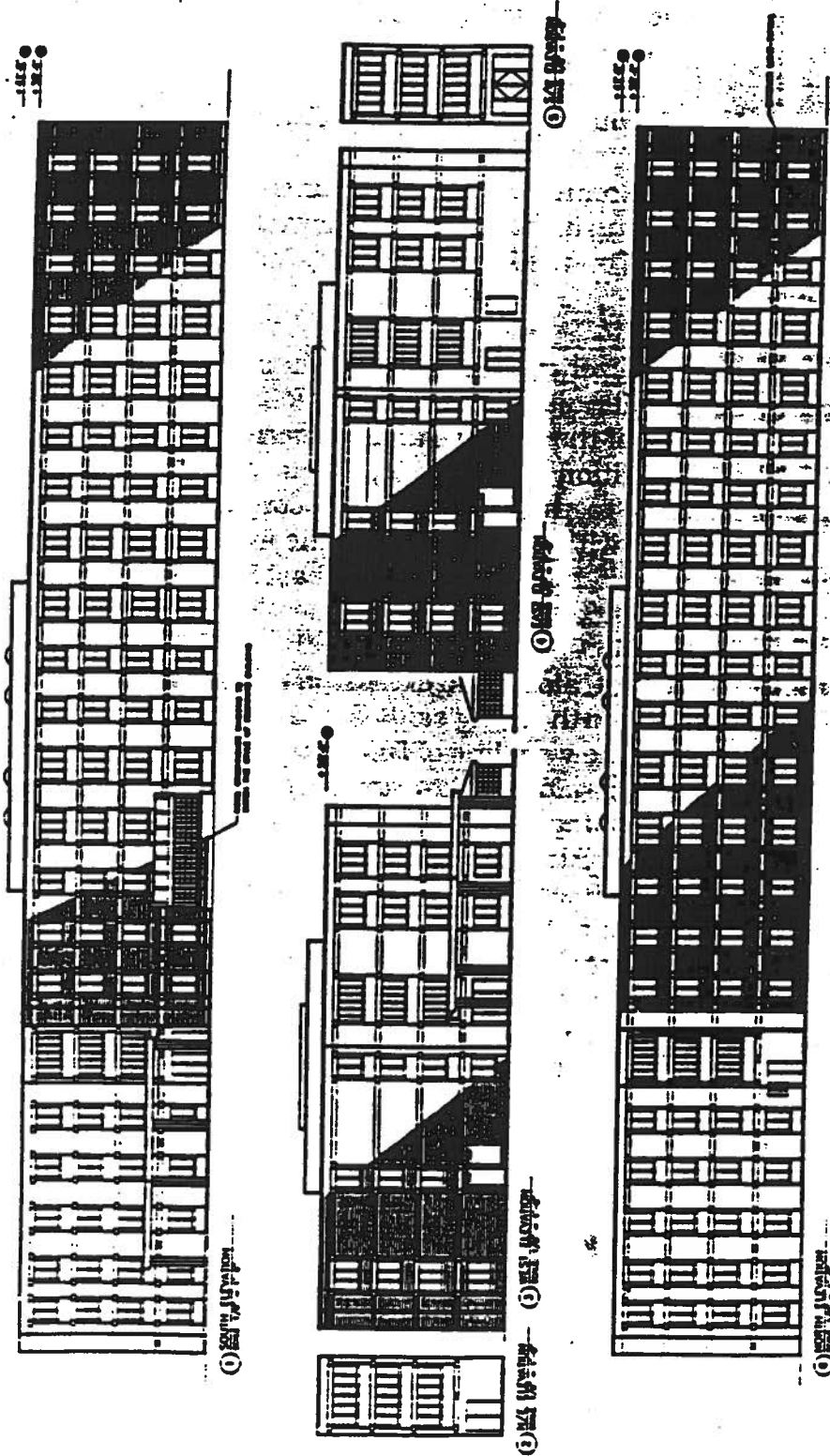

BUILDING ELEVATIONS

WHEELER HOUSE SENIOR RESIDENCES

1470 WEST 69TH STREET CHICAGO, ILLINOIS

Submission Date January 10, 2001

Revised Date February 22, 2001

Applicant Wheeler House, Inc.

SCHIFFRIN INC. CO./ITA ASSOCIATED ARCHITECTS



12877

28080

JOURNAL--CITY COUNCIL--CHICAGO

3/15/2000

~~a point starting at the southwest corner of North Kenmore Avenue and West Bryn Mawr Avenue and proceeding 150 feet west to the alley; then proceeding 100 feet south to a line parallel with West Bryn Mawr Avenue; then 150 feet east to North Kenmore Avenue; and then 100 feet north to the starting point,~~

~~to those of a B4-4 Restricted Service District and a corresponding use district is hereby established in the area above described.~~

~~SECTION 2. This ordinance shall be in force and effect from and after its passage and due publication.~~

*Reclassification Of Area Shown On Map Number 16-G.*

*(As Amended)*

*(Application Number 12877)*

*RPD 740*

*Be It Ordained by the City Council of the City of Chicago:*

SECTION 1. That the Chicago Zoning Ordinance be amended by changing all the R3 General Residence District symbols and B4-1 Restricted Service District symbols and indications as shown on Map Number 16-G in the area bounded by:

West 69<sup>th</sup> Street; South Laflin Street; the public alley next north of and parallel to West 69<sup>th</sup> Street; and a line 75 feet east of and parallel to South Bishop Street,

to those of an R5 General Residence District and a corresponding use district is hereby established in the area above described.

SECTION 2. In the area above described, the Chicago Zoning ordinance be amended by changing all of the R5 General Residence District symbols to those of a Residential Planned Development and a corresponding use is hereby established.

SECTION 3. This ordinance shall be in force and effect from and after its passage and due publication.

Plan of Development Statements referred to in this ordinance read as follows:

~~13071~~

3/15/2000

REPORTS OF COMMITTEES

28079

*Reclassification Of Area Shown On Map Number 11-H.*

(As Amended)

(Application Number A4101)

*Be It Ordained by the City Council of the City of Chicago:*

SECTION 1. That the Chicago Zoning Ordinance be amended by changing all the B3-3 General Retail District symbols and indications as shown on Map Number 11-H in the area bounded by:

West Belle Plaine Avenue; a line 135 feet west of North Damen Avenue; a line 200 feet south of West Belle Plaine Avenue; North Lincoln Avenue; a line 225 feet south of West Belle Plaine Avenue; North Damen Avenue; West Cuyler Avenue; the alley next east of and parallel to North Damen Avenue; the alley next north of and parallel to West Irving Park Road; North Wolcott Avenue; West Irving Park Road; a line 265.28 feet north of the intersection of North Damen Avenue and North Lincoln Avenue, as measured at the west right-of-way line of North Damen Avenue and perpendicular thereto; North Lincoln Avenue; West Cuyler Avenue; and the alley next westerly of North Lincoln Avenue,

to those of a B3-2 General Retail District and a corresponding use district is hereby established in the area above described.

SECTION 2. This ordinance shall be in force and effect from and after its passage and due publication.

*Reclassification Of Area Shown On Map Number 13-G.*

(As Amended)

(Application Number 12871)

*Be It Ordained by the City Council of the City of Chicago:*

SECTION 1. That the Chicago Zoning Ordinance be amended by changing all the B2-4 Restricted Retail District symbols and indications as shown on Map Number 13-G in the area bounded by:

*Residential Planned Development Number 740.*

*Plan Of Development Statements.*

1. The area delineated herein as a Residential Planned Development consists of a net site area of approximately one and two hundredths (1.02) acres (forty-four thousand four hundred seven (44,407) square feet) which is controlled by the City of Chicago ("Applicant") for purposes of this Residential Planned Development. The developer is SW Development, 7434 North Skokie Boulevard, Skokie, Illinois 60077.
2. The Applicant shall obtain all applicable official reviews, approvals or permits which are necessary to implement this Plan of Development. Any dedication or vacation of streets or alleys or easements or adjustments of right-of-ways or consolidation or resubdivision of parcels shall require separate submittal on behalf for the Applicant or its successors, assignees or grantees and approval by the City Council.
3. The requirements, obligations and conditions applicable within the Planned Development shall be binding upon the Applicant, its successors and assigns and if different than the Applicant, the owners of all the property within the Planned Development or any homeowners association(s) formed to succeed the Applicant for purposes of control and management of any portion of the Planned Development, the legal title holder or any ground lessors. Furthermore, pursuant to the requirements of Section 11.11-1 of the Chicago Zoning Ordinance, the property, at the time applications for amendments, modifications, or changes (administrative, legislative or otherwise) to this Planned Development are made, shall be under single ownership or under single designated control. Single designated control for purposes of this paragraph shall mean that any application to the City for any amendment to this Planned Development or any modification or change thereto (administrative, legislative or otherwise) shall be made by the Applicant, or the owners of all the property within the Planned Development. No amendment may be sought without written approval by the owners of the property.
4. This Plan of Development consists of these thirteen (13) statements, a Bulk Regulations and Data Table; a Planned Development Boundary and Property Line Map; an Existing Zoning and Land-Use Map; and a Site Landscape Plan and Building Elevations dated February 10, 2000, prepared by Schipporeit, Inc. and Cox Limited, which are all incorporated herein. Full size sets of the Site Landscape Plan and Building Elevations are on file with the Department of Planning and Development. This Plan of Development is in conformity with the intent and purposes of the Chicago

Zoning Ordinance (Title 17 of the Municipal Code of Chicago) and all requirements thereof and satisfies the established criteria for approval of a Planned Development. These and no other controls shall apply to the area delineated herein.

5. The following uses shall be permitted within the areas delineated herein:

multi-family dwelling units for the elderly; accessory parking; and related accessory uses.
6. Identification signs shall be permitted within the Planned Development subject to the review and approval of the Department of Planning and Development. Temporary signs, such as construction and marketing signs shall be permitted within the Planned Development subject to review and approval of the Department of Planning and Development.
7. Any service drives or other ingress or egress including emergency vehicle access shall be adequately designed, constructed and paved in accordance with the Municipal Code of Chicago and the regulations of the Department of Transportation in effect at the time of construction. There shall be no parking or storage of garbage receptacles within such paved areas. Ingress and egress shall be subject to the review and approval of the Department of Transportation and the Department of Planning and Development. Off-street parking and off-street loading facilities shall be provided in compliance with this Plan of Development subject to review of the Departments of Transportation and Planning and Development.
8. In addition to the maximum height of any building or any appurtenance attached thereto the height of any improvement shall also be subject to height limitations as approved by the Federal Aviation Administration.
9. The maximum permitted floor area ratio shall be in accordance with the attached Bulk Regulations and Data Table. For purposes of F.A.R. calculations and floor area measurements, the definition in the City of Chicago Zoning Ordinances shall apply.
10. Improvements of the property, including landscaping and all entrances and exits shall be designed and installed in substantial conformance with the Bulk Regulations and Data Table and the Site Plan attached hereto and made a part hereof. Landscaping shall be installed and maintained at all times in accordance with the Landscape Plan and the Parkway Tree Provisions of the Chicago Zoning Ordinance and corresponding regulations and guidelines. Installation of parkway landscaping is subject to review and permit by any departments or agencies required to approve same.

11. The terms, conditions and exhibits of this planned development ordinance may be modified, administratively, by the Commissioner of the Department of Planning and Development upon the written request for such modification by the Applicant and after a determination by the Commissioner of the Department of Planning and Development, that such a modification is minor, appropriate and is consistent with the nature of the improvements contemplated in this planned development. Any such modification of the requirements of this statement by the Commissioner of the Department of Planning and Development shall be deemed to be a minor change in the planned development as contemplated by Section 11.11-3(c) of the Chicago Zoning Ordinance.
12. The Applicant acknowledges that it is in the public interest to design, construct and maintain all buildings in a manner which promotes, enables and maximizes universal access throughout the property. Plans for all buildings and improvements on the property shall be reviewed and approved by the Mayor's Office for People with Disabilities (M.O.P.D.) to ensure compliance with all applicable laws and regulations related to access for persons with disabilities and to promote the highest standard of accessibility. No approvals shall be granted pursuant to Section 11.11-3(b) of the Chicago Zoning Ordinance until the Director of M.O.P.D. has approved detailed construction drawings for each building or improvement.
13. If substantial construction has not yet begun within the Planned Development within six (6) years of the date of passage of the Planned Development, the zoning of that property shall revert to the underlying R3 General Residence District and B4-1 Restricted Service District. The six (6) year period may be extended for one (1) additional year if, before expiration, the Commissioner of the Department of Planning and Development determines that there is good cause for such an extension.

[Existing Zoning and Land-Use Map; Planned Development Boundary and Property Line Map; Site Plan; Landscaping Plan; Building Elevation Drawings; and Ornamental Metal Fence and Grate Drawing referred to in these Plan of Development Statements printed on pages 28086 through 28091 of this Journal.]

Bulk Regulations and Data Table and Exterior Materials Used for Wheeler House referred to in these Plan of Development Statements read as follow:

*Residential Planned Development Number 740.*

*Bulk Regulations And Data Table.*

Gross Site Area:	83,273.45 square feet (9.91 acres).
Net Site Area:	Total = Gross Site Area (47,533 square feet)- Area in Public Street and Alleys = Net Site Area of 44,407 square feet (1.02 acres).
Maximum Floor Area Ratio:	1.53.
Maximum Number of Residential Units:	89 units.
Maximum Site Coverage:	In accordance with Site Plan.
Minimum Number of Off-Street Parking Spaces:	28.
Minimum Number of Off-Street Loading Spaces:	1.
Minimum Building Setbacks:	In accordance with Site Plan.
Maximum Building Height:	In accordance with Building Elevations.

*Exterior Materials For Wheeler House.*

- Brick.
- Limestone lintels and sills.
- Limestone Rosettes with granite inset.
- Anodized aluminum window frames (green).
- Windows-glass/double glazed.

- Front entrance -- anodized aluminum store front.
- Canopy columns --brick.
- Spandrel -- E.I.P.s
- Exit doors -- steel/painted.
- Greenhouse -- roof glass

E.I.F.s on odd shaped panels

walls are glass and brick.

—

*Reclassification Of Area Shown On Map Number 17-H.*  
(Application Number 12696)

*Be It Ordained by the City Council of the City of Chicago:*

SECTION 1. That the Chicago Zoning Ordinance be amended by changing all the R4 General Residence District symbols and indications as shown on Map Number 17-H in the area bounded by:

the alley next north of and parallel to West Pratt Boulevard; the alley next west of and parallel to North Clark Street; West Pratt Boulevard; and a line 268.68 feet east of North Ravenswood Avenue,

to those of a C2-2 General Commercial District and a corresponding use district is hereby established in the area above described.

(Continued on page 28092)

Existing Zoning And Land-Use Map.

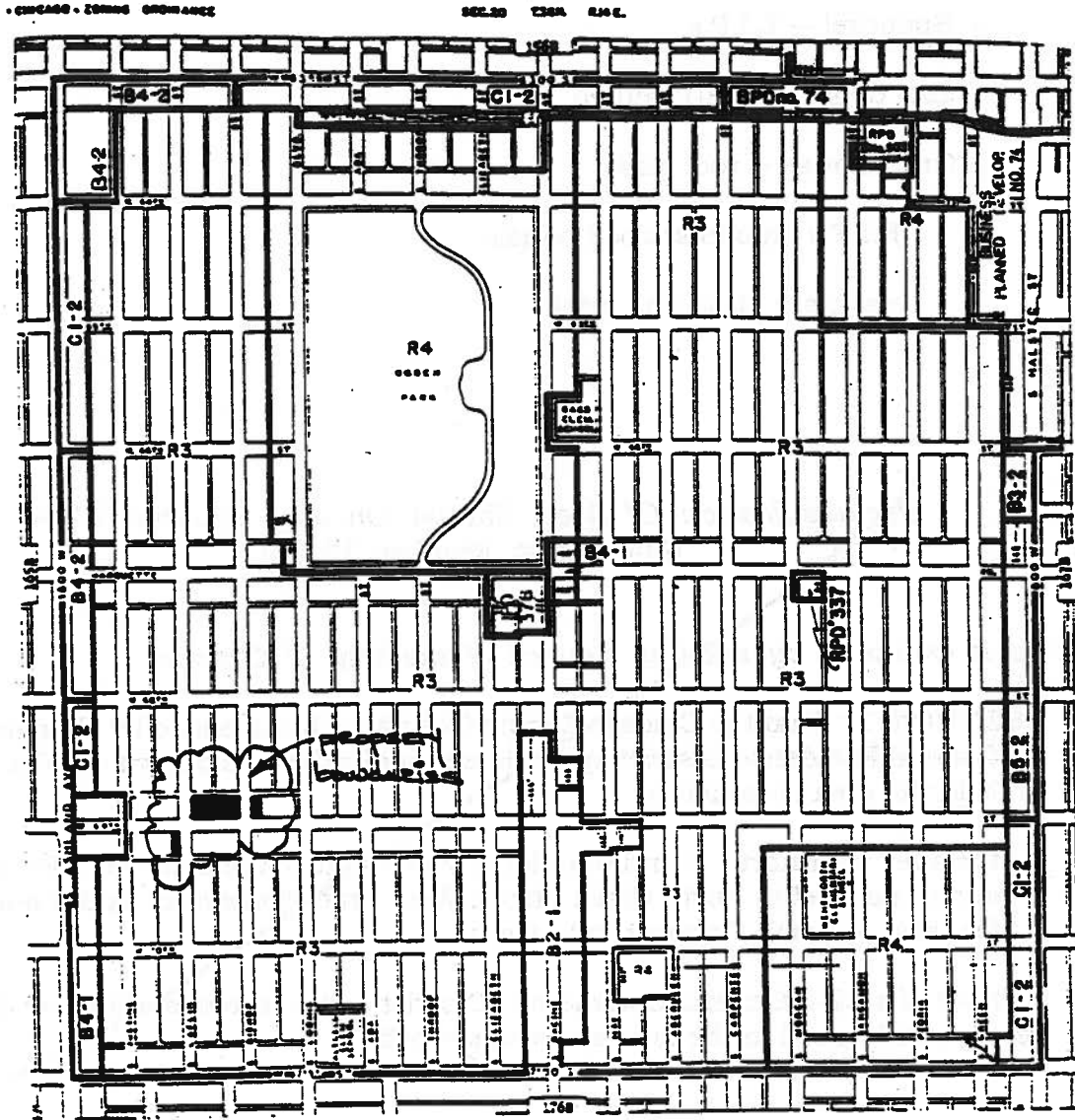

Planned Development Boundary  
And Property Line Map.

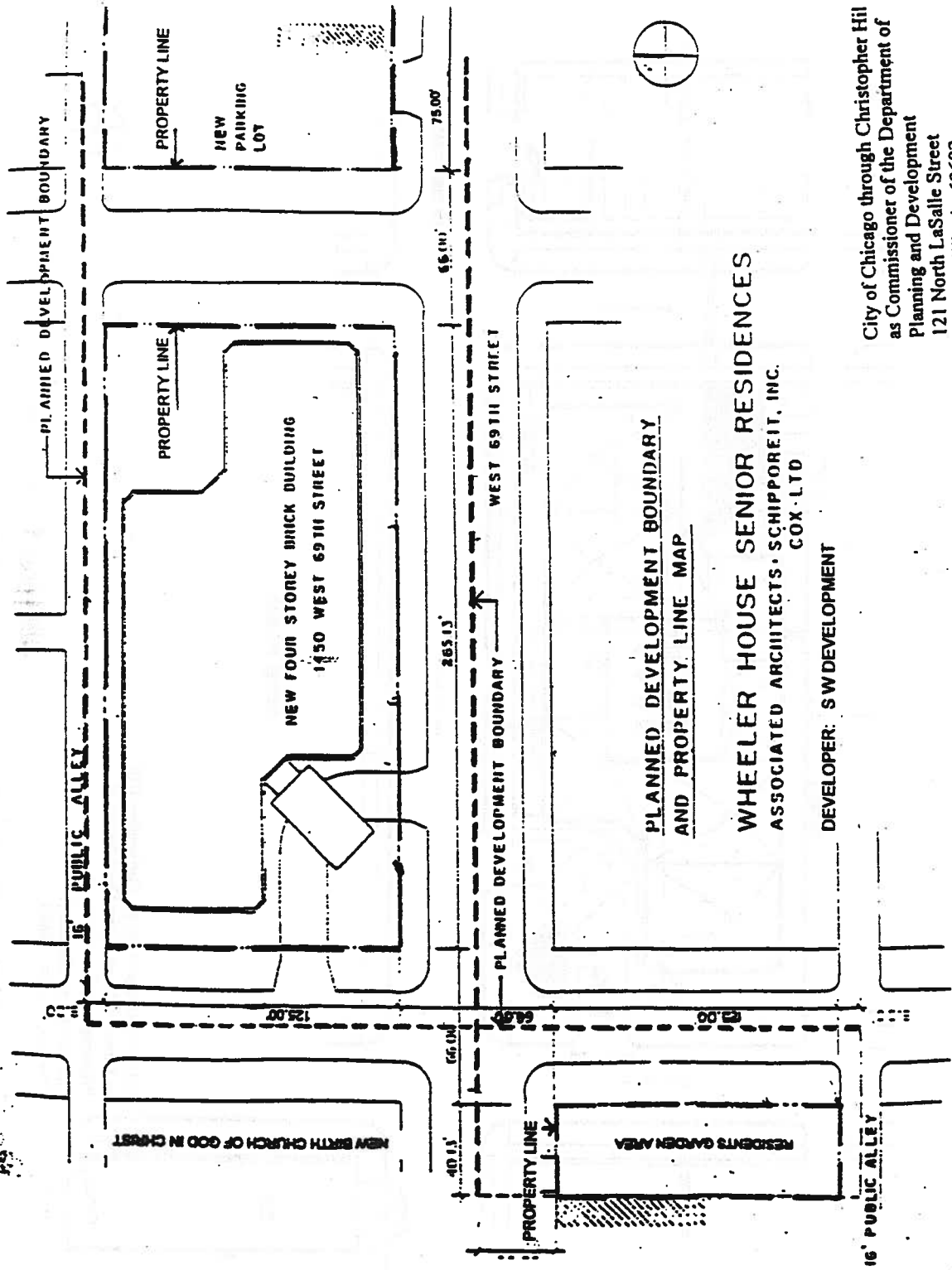

PLANNED DEVELOPMENT BOUNDARY  
AND PROPERTY LINE MAP

**WHEELER HOUSE SENIOR RESIDENCES**  
ASSOCIATED ARCHITECTS · SCHIPPOREIT, INC.  
COX · LTD

DEVELOPER: SWDEVELOPMENT

City of Chicago through Christopher Hill  
as Commissioner of the Department of  
Planning and Development  
121 North LaSalle Street  
CHICAGO, ILLINOIS 60602

Site Plan.

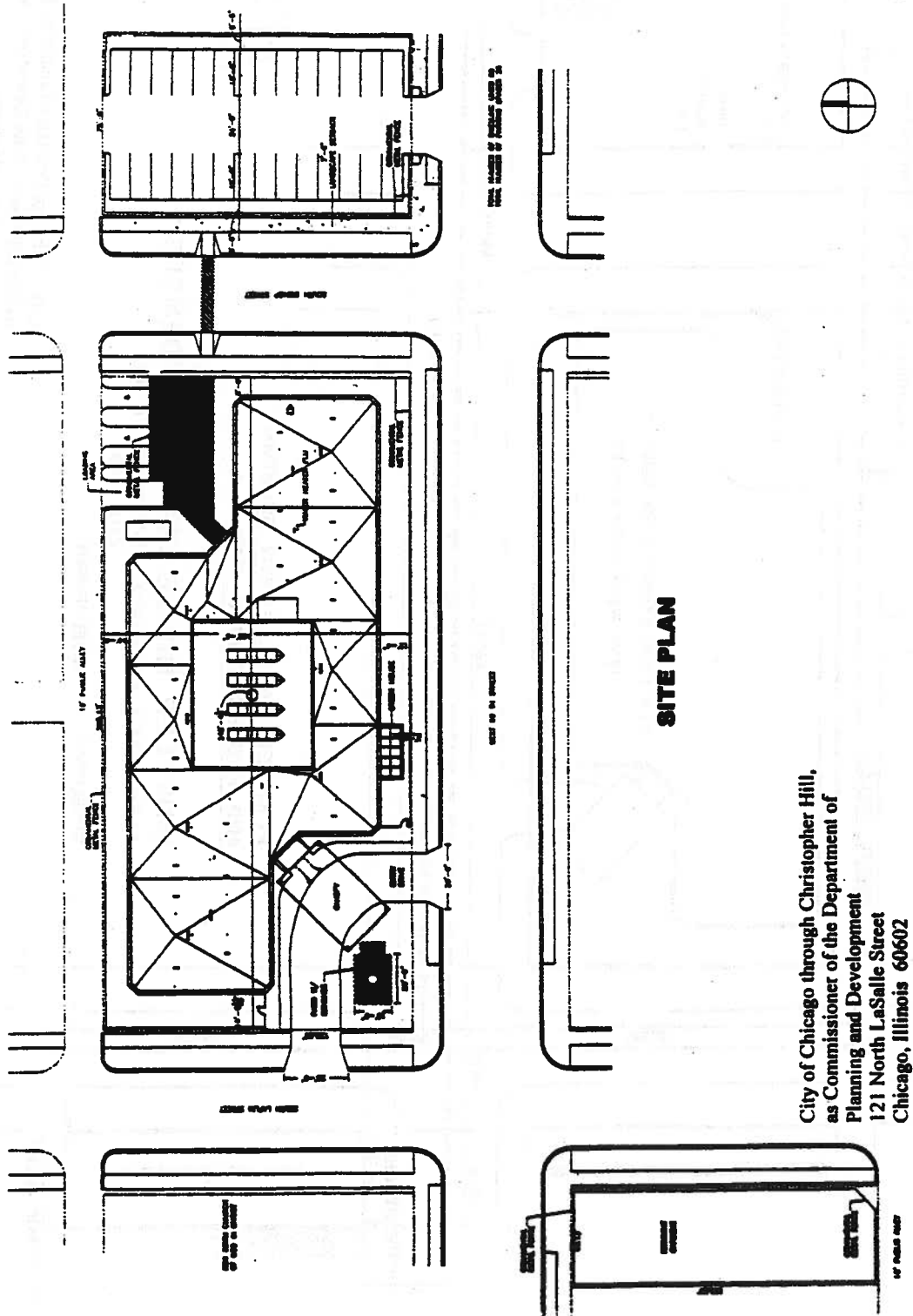

SITE PLAN

City of Chicago through Christopher Hill,  
 as Commissioner of the Department of  
 Planning and Development  
 121 North LaSalle Street  
 Chicago, Illinois 60602

**SCHIFFORD INC. & LTD.**  
 ASSOCIATED ARCHITECTS

SPONSOR: NEW BIRTH CHURCH OF GOD IN CHRIST  
 DEVELOPER: SW DEVELOPMENT

**WHEELER HOUSE SENIOR RESIDENCES**  
 1480 WEST 68TH STREET CHICAGO, ILLINOIS

Landscape Plan.

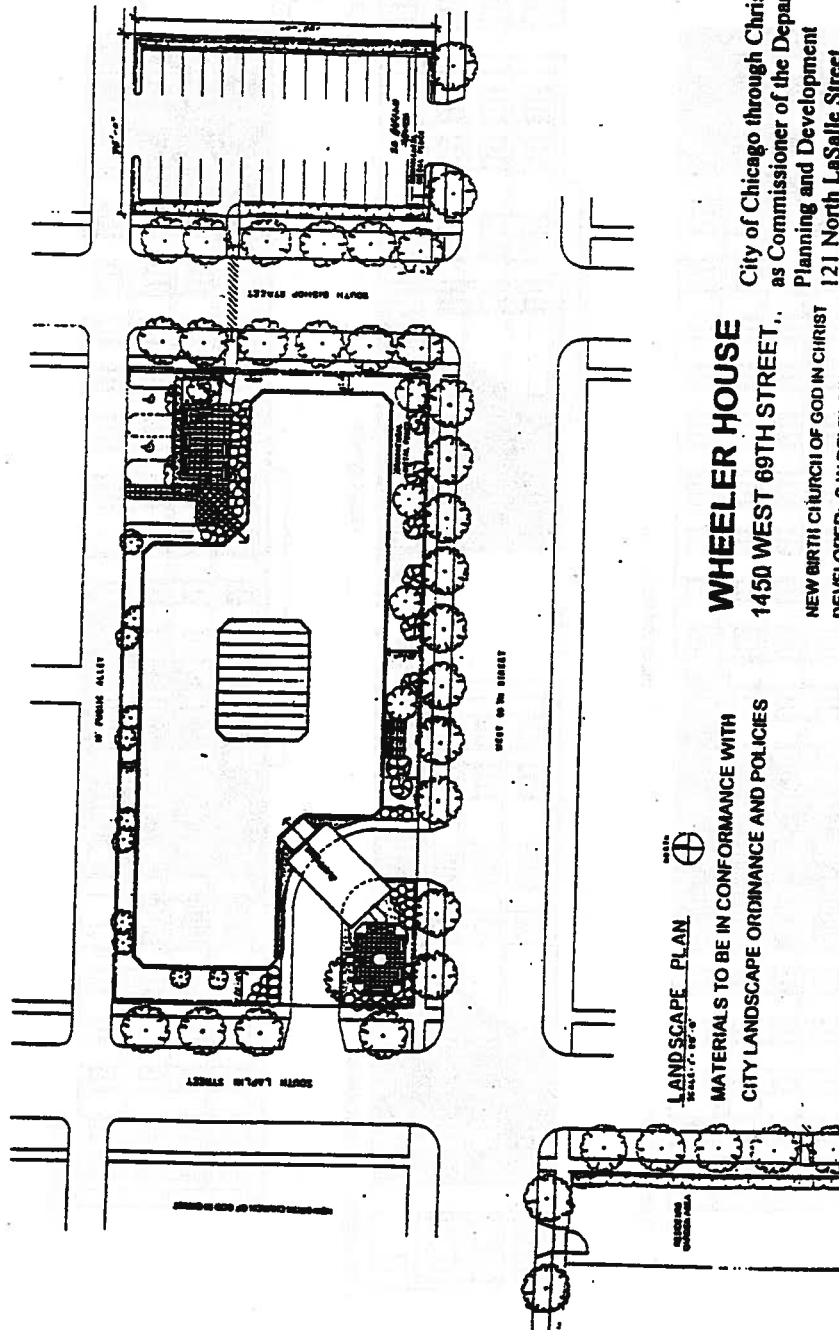

LANDSCAPE PLAN  
SCALE: 1/8" = 1'-0"

MATERIALS TO BE IN CONFORMANCE WITH  
CITY LANDSCAPE ORDINANCE AND POLICIES

**WHEELER HOUSE**  
1450 WEST 69TH STREET.

NEW BIRTH CHURCH OF GOD IN CHRIST  
DEVELOPER: S W DEVELOPMENT

City of Chicago through Christopher Hill,  
as Commissioner of the Department of  
Planning and Development  
121 North LaSalle Street  
Chicago, Illinois 60602

Building Elevations.

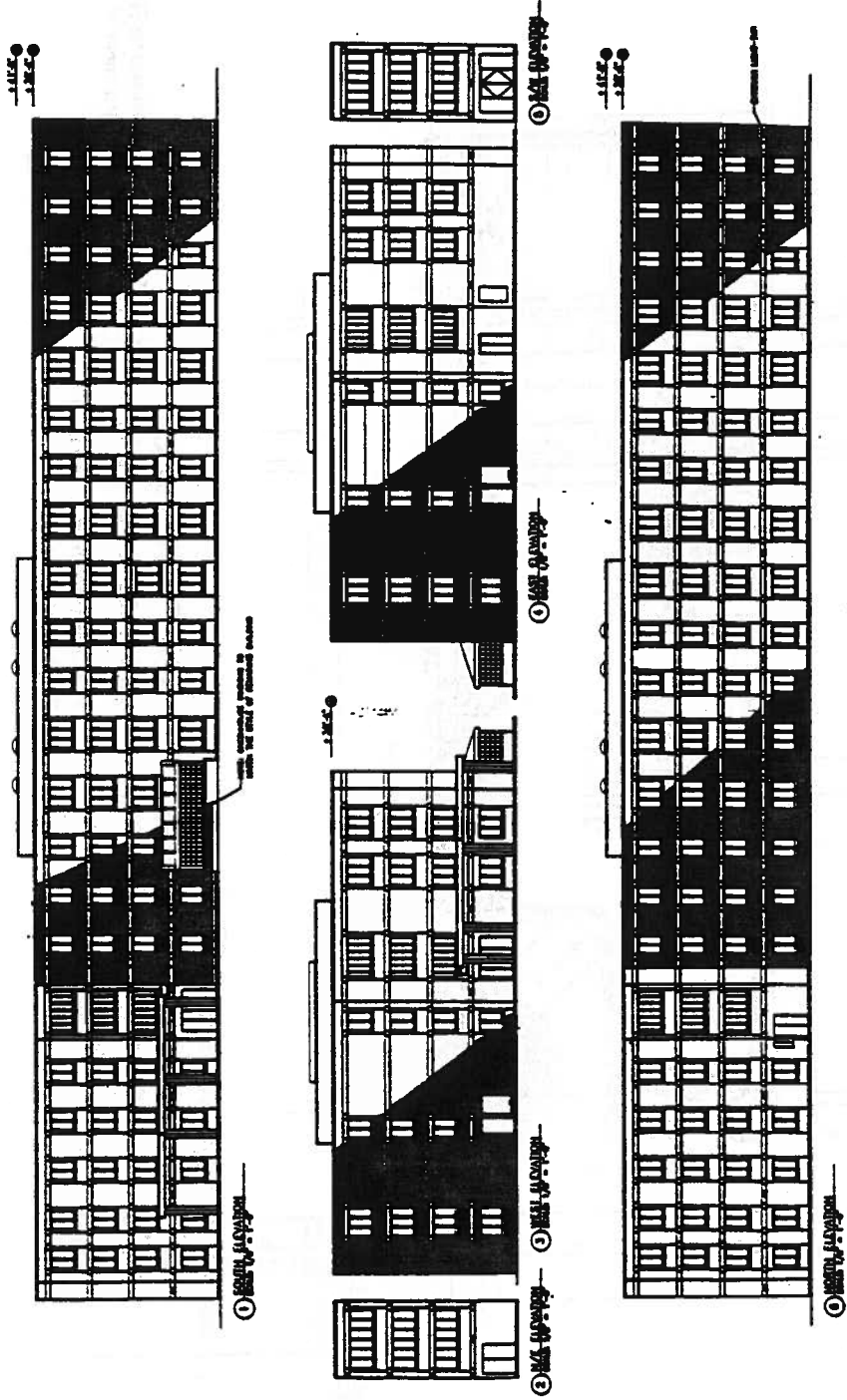

Building Elevations

City of Chicago through Christopher Hill,  
 as Commissioner of the Department of  
 Planning and Development  
 121 North LaSalle Street  
 Chicago Illinois 60602

SPONSOR: NEW BIRTH CHURCH OF GOD IN  
 DEVELOPER: SW DEVELOPMENT

**WHEELER HOUSE SENIOR RESIDENCES**  
 146Q WEST 69TH STREET CHICAGO, ILLINOIS

Ornamental Metal Fence And Gate.

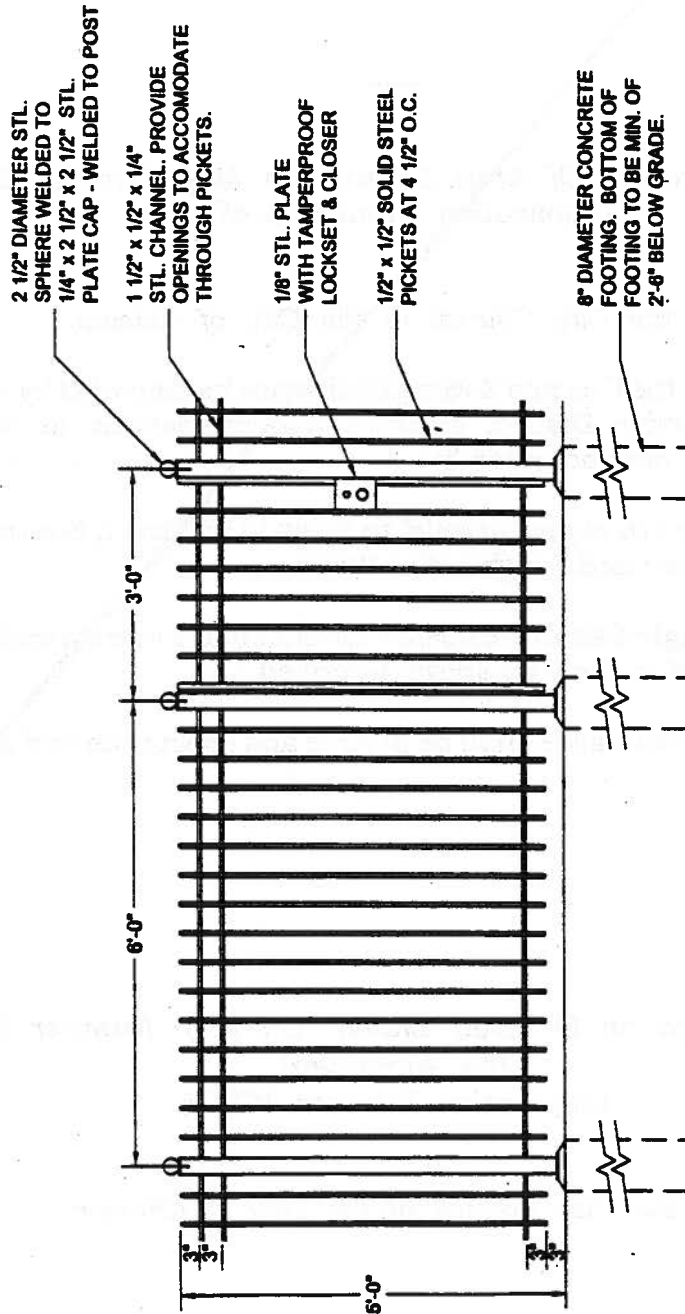

Building Elevations (part of)

City of Chicago through Christopher Hill,  
as Commissioner of the Department of  
Planning and Development  
121 North LaSalle Street  
Chicago, Illinois 60602

**ORNAMENTAL METAL FENCE & GATE**

(Continued from page 28085)

SECTION 2. This ordinance shall be in force and effect from and after its passage and due publication.

---

*Reclassification Of Area Shown On Map Number 28-G.  
(Application Number A-4274)*

*Be It Ordained by the City Council of the City of Chicago:*

SECTION 1. That the Chicago Zoning Ordinance be amended by changing all the B4-1 Restricted Service District symbols and indications as shown on Map Number 28-G in the area bounded by:

the alley next north of and parallel to West 115<sup>th</sup> Street; South Bishop Street; West 115<sup>th</sup> Street; and South Laflin Street,

to those of an R2 Single-Family Residence District and a corresponding use district is hereby established in the area above described.

SECTION 2. This ordinance shall be in force and effect from and after its passage and due publication.

---

*Reclassification Of Area Shown On Map Number 28-I.  
(As Amended)  
(Application Number 12870)*

*Be It Ordained by the City Council of the City of Chicago:*